

Formed Using a Standard 12"x118.7" Flat Sheet

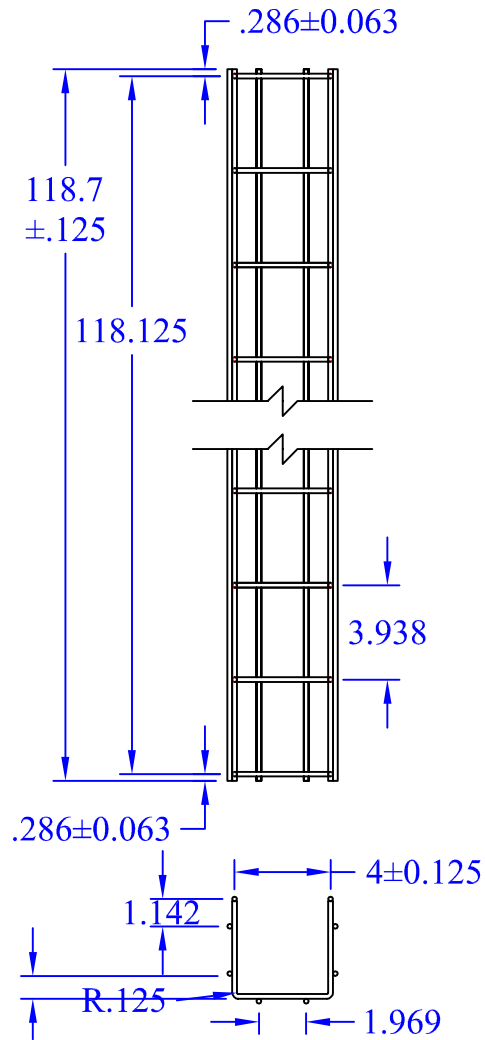

General Notes:

- 1) Material:
 - A. Regular Galvanized Wire Per ASTM A641
 - B. Carbon Steel Bright Basic Wire Per ASTM A510 Grade 1008
- 2) Material Thickness:
 - A. Longitudinal & Rib Wire \varnothing : 5 mm = .197"
- 3) Carbon Finish: (Carbon Steel Wire Only)
 - A. Electrodeposited Zinc, Type III Finish, per ASTM B633
 - B. Polyester Powder Coating 1.2mm - 3.0mm TK
- 4) Dimensional Tolerances
 - A. As Shown on Drawing, Generally $\pm .125$ " U.N.O.
 - B. Wire Twist Tolerance: $\pm .5$ " on a Standard 10' Section
- 5) Bend Radius:
 - A. R .125" ($\pm .0625$), TYP. U.N.O.



This drawing in design and detail is the property of WBT, LLC. and must not be used except in connection with our work. All rights of design or invention are reserved.

PART # OR NAME			DRAWN BY	
WBT 4x4 Round			RJM	
SIZE	DATE	SCALE	SHEET	REV
A	11/11/15	1-1/2"=1'	1 OF 1	N/A