

General Notes:

- 1) Material to be commercial quality mill galvanized steel per ASTM A653 w/ G-90 coating . Min Yield = 33 KSI
- 2) Dimensional Tolerances:
 - A) General: $\pm .03$ "
 - B) Angular: $\pm 2^\circ$
 - C) Hole location: $\pm 1/32$ " (.8mm)
- 3) Material Thickness Min 22 GA = .032"
- 4) All Angles to be 90° U.N.O.
- 5) Finish: Electroplated After Fabrication

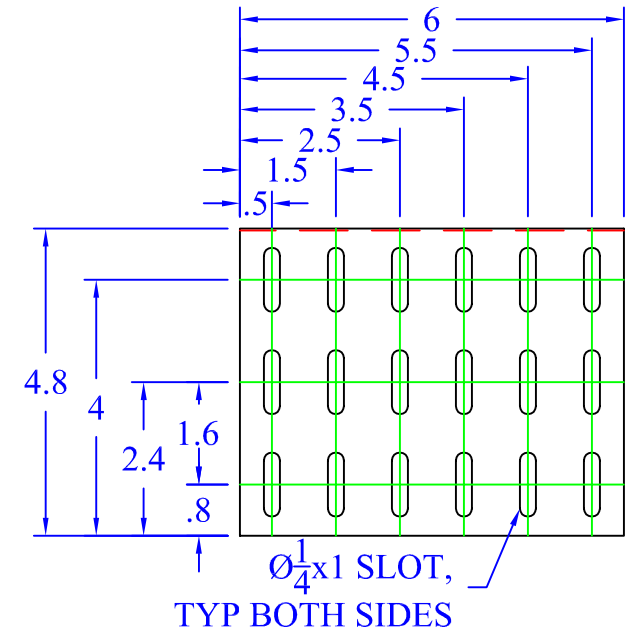
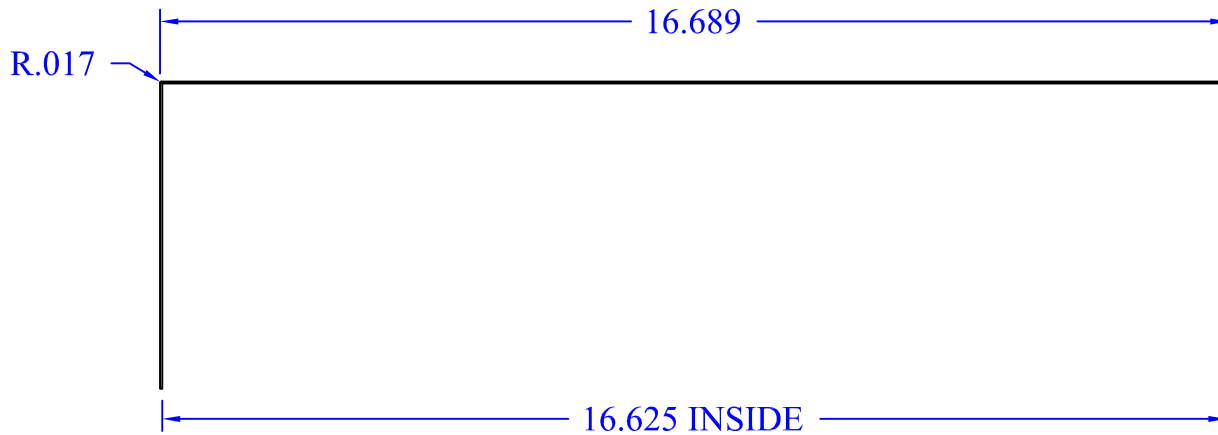

This drawing in design and detail is the property of WBT, LLC. and must not be used except in connection with our work. All rights of design or invention are reserved.

PART # OR NAME 6x16 BLIND END			DRAWN BY RJM	
SIZE A	DATE 1/22/16	SCALE 4"=1'	SHEET 1 OF 1	REV N/A